

NS-P125

HOME CINEMA CENTER & EFFECT SPEAKERS

NS-C125/NS-M125

SPEAKER SYSTEM

Thank you for choosing a Yamaha speaker system.

- NS-P125 are speaker sets consisting of the components shown on the table.

NS-P125	• Center speaker	NS-C125 x 1
	• Effect (Surround) speakers	NS-M125 x 2

- The NS-C125 speaker is designed for use as the center speaker in a surround sound system.
- NS-M125 speakers are designed for use as front or surround speakers in a surround sound system.

Caution

■ Read the following before using these speakers:

- To assure the finest performance, please read this manual carefully. Keep it in a safe place for future reference.
- Install the speakers in a cool, dry, clean place away from windows, heat sources, sources of excessive vibration, dust, moisture and cold. Avoid sources of humming (transformers, motors). To prevent fire or electric shock, do not expose the speakers to dripping or splashing.
- To prevent the enclosure from warping or discoloring, do not place the speakers where they will be exposed to direct sunlight or excessive humidity.
- Do not place the following objects on top of the speakers:
 1. Glass, china, etc.
If glass etc. falls by vibrations and breaks, it may cause personal injury.
 2. A burning candle etc.
If the candle falls by vibrations, it may cause fire and personal injury.
 3. A vessel with water in it
If the vessel falls by vibrations and water spills, it may cause damage to the unit, and/or you may get an electric shock.
- Do not place the speakers where foreign objects such as water drips might fall. It might cause a fire, damage to this unit, and/or personal injury.
- Do not place the speakers where they are liable to be knocked over or struck by falling objects. Stable placement will also ensure better sound performance.
- Secure placement or installation is the owner's responsibility. Yamaha shall not be liable for any accident caused by improper placement or installation of speakers.
- Any time you note distortion, reduce the volume of your amplifier immediately. Make sure the input power does not exceed the specified maximum input power, otherwise the speakers will be damaged.
- Do not attempt to clean the speakers with chemical solvents as this might damage the finish. Use a clean, dry cloth.
- Do not attempt to modify or fix the speakers. Contact qualified Yamaha service personnel when any service is needed. The cabinet should never be opened for any reasons.

Note:

The speakers are magnetically shielded, but placing them too close to a TV may impair the TV picture. If this happens, move them away from the TV.

Supplied Accessories

- **NS-M125**

Speaker cable (10 m): 1 pc./unit

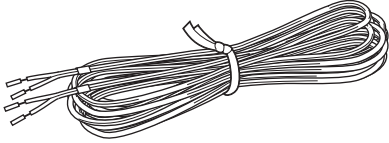

- **NS-C125**

Speaker cable (4 m)



Fasteners x 2

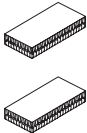

Setting Up the Speakers

Place the speakers on a sturdy, vibration-free surface, such as a well-built stand.

■ Using the NS-M125 as Normal Stereo Speakers

To get the best stereo performance, angle the speakers inward so as to create a triangle, with the listener at the apex.

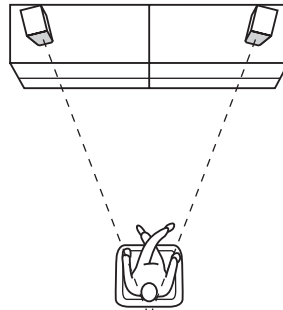

■ Using the NS-M125 as Front Speakers in a Surround Sound System

Position the speakers both side of your TV. The positioning of these speakers is important because they provide a solid anchor for the sound image. They should be positioned facing the listener at about ear level, and equidistant from the TV.

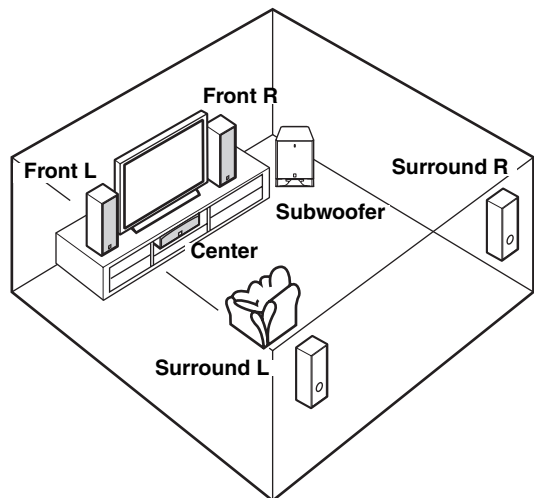

■ Using the NS-M125 as surround speakers in a surround sound system

The speakers can be mounted on a wall by using the bracket attached to the speakers' back panels.

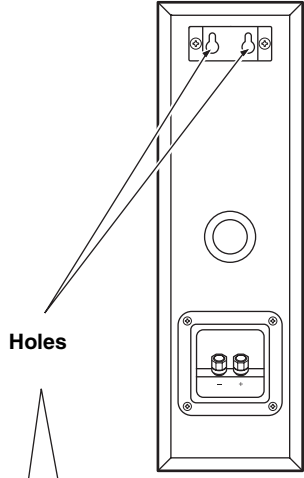

Make sure that the screws are caught by a narrow part of the holes securely.

Fasten screws into a firm wall or wall support as shown in the figure below, and hang the holes on the protruding screws.

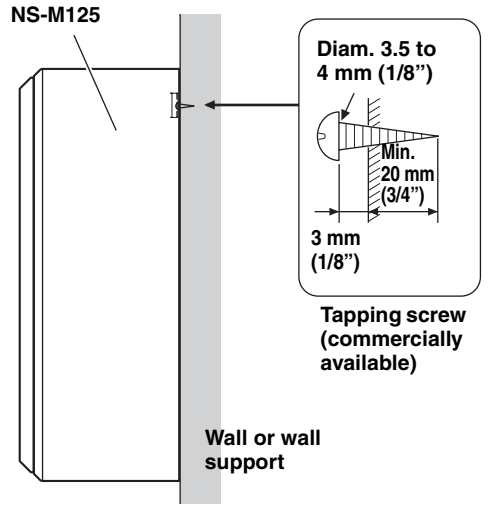

WARNING:

- Each speaker weights 2 kg (4.4 lbs). Do not mount them on thin plywood or soft wall surface material, as the screws may come out of the flimsy surface, causing the speakers to fall down and be damaged, or result in personal injury.
- Do not fasten the speakers to wall with nails, adhesives, or other unsound hardware. Long term use and vibrations may cause them to fall down.
- To avoid accidents resulting from tripping over loose speaker cords, fix them to the wall.

Note:

You can also use the screw holes on the bottom of the NS-M125 for installing the speakers on commercially available speaker stands.

- Before installing, please refer to the instruction manual of the speaker stand.

■ Placing the center speaker NS-C125

Place the speaker on the floor under the TV or inside the TV rack so that it is stabilized.

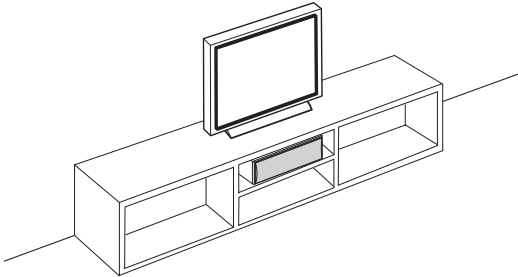

When placing the speaker on top of the TV

To prevent the speaker from falling down, put the provided fasteners at two points on both bottom of the speaker and top of the TV.

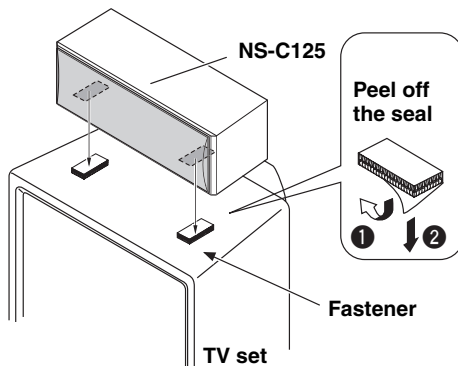

Notes:

- Do not place the speaker on top of the TV whose area is smaller than the bottom area of the speaker. If placed, the speaker may drop out causing an injury to you.
- Do not place the speaker on top of the TV with an inclination.
- Do not touch the adhesive surface after peeling off the seal as this will weaken its adhesive strength.
- Thoroughly wipe clean the surface where the fastener is to be applied. Note that adhesive strength is weakened if the surface is dirty, oily or wet and that this may cause the center speaker to drop.

■ Mounting the center speaker NS-C125 on the wall

The speaker can be mounted on a wall by using the bracket attached to the speaker's back panel.

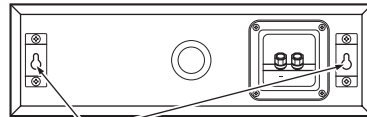

Holes

Make sure that the screws are caught by a narrow part of the holes securely.

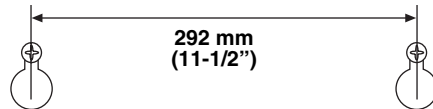

Fasten screws into a firm wall or wall support as shown in the figure below, and hang the holes on the protruding screws.

NS-C125

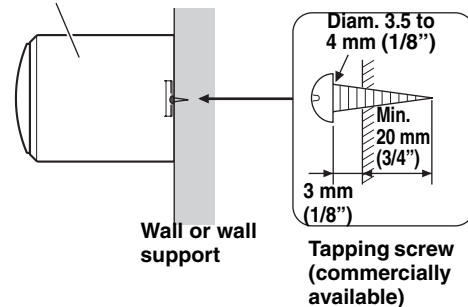

WARNING:

- The speaker weighs 2 kg (4.4 lbs). Do not mount them on thin plywood or soft wall surface material, as the screws may come out of the flimsy surface, causing the speakers to fall down and be damaged, or result in personal injury.
- Do not fasten the speakers to wall with nails, adhesives, or other unsound hardware. Long term use and vibrations may cause them to fall down.
- To avoid accidents resulting from tripping over loose speaker cords, fix them to the wall.

Connecting Your Speakers

Always turn off your amplifier or receiver before making any connections.

■ Preparing Your Speaker Cables

Carefully remove 10 mm (3/8 ") of insulation from both ends of your speaker cables and twist the bare wires tightly, as shown.

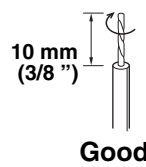

■ Hookup

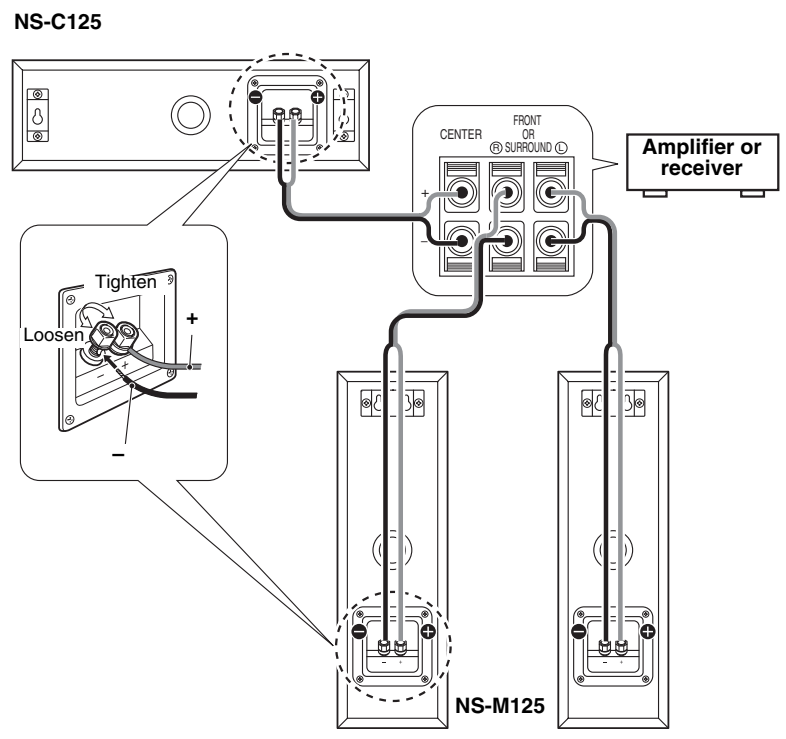

Notes:

- Make sure that the bare wires are not touching each other as this could damage the speaker and amplifier.
- Connect one speaker to the left terminals of your amplifier, and another speaker to the right terminals, making sure not to reverse the polarity (+, -). If one speaker is connected with reversed polarity, the sound will be unnatural and lack bass.

■ Using a Banana Plug

1. Remove the speaker terminal cover by gently pulling it toward you.
2. Tighten the terminal knob.
3. Simply insert the banana plug into the terminal.

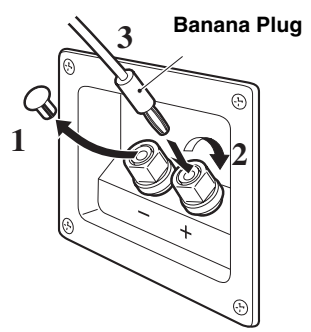

Specifications

NS-M125

Type..... 2-way bass reflex speaker system
magnetic shielding type

Driver 8 cm (3-1/8") cone woofer x 2
2.2 cm (7/8") balanced dome tweeter

Impedance 6 Ω

Frequency Response 70 Hz to 35 kHz

Nominal Input Power 40 W

Maximum Input Power 120 W

Sensitivity 86 dB/2.83 V/m

Crossover Frequency..... 6 kHz

Dimensions (W x H x D)
..... 105 (4.1") x 340 (13.4") x 133 (5.2") mm

Weight..... 2 kg (4.4 lbs)

NS-C125

Type..... 2-way bass reflex speaker system
magnetic shielding type

Driver 8 cm (3-1/8") cone woofer x 2
2.2 cm (7/8") balanced dome tweeter

Impedance 6 Ω

Frequency Response 70 Hz to 35 kHz

Nominal Input Power 40 W

Maximum Input Power 120 W

Sensitivity..... 86 dB/2.83 V/m

Crossover Frequency..... 6 kHz

Dimensions (W x H x D)
..... 340 (13.4") x 105 (4.1") x 132 (5.2") mm

Weight..... 2 kg (4.4 lbs)

* Specifications are subject to change without notice due to product improvements.



This product mainly uses lead-free solder.
Cet appareil utilise principalement de la soudure sans plomb.
Dieses Produkt verwendet hauptsächlich bleifreies Lot.
Este producto utiliza principalmente soldadura sin plomo.

©2004 YAMAHA CORPORATION All rights reserved.

YAMAHA ELECTRONICS CORPORATION, USA 6660 ORANGETHORPE AVE., BUENA PARK, CALIF. 90620, U.S.A.
YAMAHA CANADA MUSIC LTD. 135 MILNER AVE., SCARBOROUGH, ONTARIO M1S 3R1, CANADA
YAMAHA ELECTRONIK EUROPA G.m.b.H. SIEMENSSTR. 22-34, 25462 RELLINGEN BEI HAMBURG, F.R. OF GERMANY
YAMAHA ELECTRONIQUE FRANCE S.A. RUE AMBROISE CROIZAT BP70 CROISSY-BEAUBOURG 77312 MARNE-LA-VALLEE CEDEX02, FRANCE
YAMAHA ELECTRONICS (UK) LTD. YAMAHA HOUSE, 200 RICKMANSWORTH ROAD WATFORD, HERTS WD18 7GQ, ENGLAND
YAMAHA SCANDINAVIA A.B. J A WETTERGRENS GATA 1, BOX 30053, 400 43 VÄSTRA FRÖLUNDA, SWEDEN
YAMAHA MUSIC AUSTRALIA PTY, LTD. 17-33 MARKET ST., SOUTH MELBOURNE, 3205 VIC., AUSTRALIA

YAMAHA CORPORATION
Printed in Indonesia  WD74170-1